

MAX™ Wireless



Installation & Operation Manual

**ClearOne.**

## Table of Contents

Introduction .....	1
Service and support .....	1
Product returns .....	1
Unpacking .....	2
Safety .....	2
Getting Started .....	4
Connecting your conferencing phone .....	4
Connecting to a digital phone line .....	6
Using your MAX Wireless conferencing phone .....	6
User Options .....	8
Call features .....	8
Programming features .....	9
Tones and alerts .....	11
Maintenance .....	12
Caring for your MAX Wireless .....	12
Electrical considerations .....	12
Troubleshooting .....	12
Appendix .....	14
Specifications .....	14
Compliance .....	15
Warranty .....	18

MAX Wireless Installation and Operation Manual  
 ClearOne Part No. 800-158-001 September 2006 (Rev. 3.1)  
 U.S. Patent No. D499,392.

© 2004 ClearOne Communications, Inc. All rights reserved. No part of this document may be reproduced in any form or by any means without written permission from ClearOne Communications. ClearOne Communications reserves specific privileges. Information in this document is subject to change without notice.

## Introduction

Thank you for purchasing the ClearOne MAX™ Wireless conferencing phone. Ideal for small conference rooms with up to eight participants, MAX Wireless provides the convenience of wireless without compromising on audio quality or call security. MAX Wireless is built using the WDCT and DECT wireless standards (depending on model); standards characterized by reliability, stability, and excellent sound quality. And with twelve-hour talk-time between recharging, you'll have plenty of time to experience the difference Max Wireless will make to the way you communicate.

- **Wireless.** MAX Wireless makes any room a conference room and provides a clean look with no wires on the table or floor.
- **Superior Audio.** The clear, full sound of MAX Wireless facilitates more natural interaction among participants.
- **Easy to Use.** The intuitive, user friendly controls are simple to operate.

## Service and support

If you need additional information on how to set up or operate your Max Wireless conferencing phone, please contact us. We welcome and encourage your comments so we can continue to improve our products and better meet your needs.

## Technical Support

Tel: 1-800-283-5936(USA) or 1-801-974-3760  
 Fax: 1-801-977-0087  
 E-mail: [tech.support@clearone.com](mailto:tech.support@clearone.com)  
 Web: [www.clearone.com](http://www.clearone.com)

## Sales and Customer Service

Tel: 1-800-945-7730 (USA) or 1-801-975-7200  
 Fax: 1-800-933-5107 (USA) or 1-801-977-0087  
 E-mail: [sales@clearone.com](mailto:sales@clearone.com)

## Product returns

All product returns require a return materials authorization (RMA) number. Please contact ClearOne Technical Support before attempting to return your product. Make sure you return all the items that shipped with your product.

## Unpacking

Carefully place the conferencing pod and base unit on a level surface. Ensure you have received all items shown below.

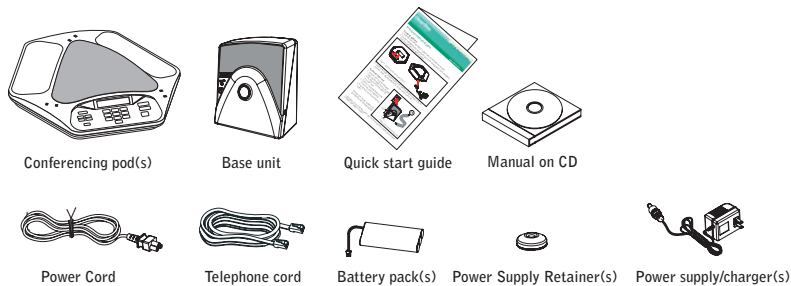

**Figure 1. MAX Wireless parts**

 ClearOne is not responsible for product damage incurred during shipment. You must make claims directly with the carrier. Inspect your shipment carefully for obvious signs of damage. If the shipment appears damaged, retain the original boxes and packing material for inspection by the carrier. Contact your carrier immediately.

 The MAXAttach Wireless model contains two pods, two battery packs, and two power supply/chargers & retainers. For more information on MAXAttach Wireless, see pg 12.

## Important safety information

Read the safety instructions before first use of this product. This conferencing phone is not designed for making emergency telephone calls when the power fails. Make alternative arrangements for access to emergency services.

- Read and understand all instructions.
- Follow all warnings and instructions marked on the product.
- Unplug this product from the wall outlet before cleaning. Do not use liquid cleaners or aerosol cleaners. Use a damp cloth for cleaning.
- Do not use this product near water, for example, near a bathtub, washbowl, kitchen sink, or laundry tub, in a wet basement, or near a swimming pool.
- Do not place this product on an unstable cart, stand, or table. The product may fall, causing serious damage to the product.
- Slots and openings in the cabinet and the back or bottom are provided for ventilation, to protect it from overheating, these openings must not be blocked or covered.
- This product should never be placed near or over a radiator or heat register. This product should not be placed in a built-in installation unless proper ventilation is provided.

- This product should be operated only from the type of power source indicated on the marking label. If you are not sure of the type of power supply in your location, consult your dealer or local power company.
- Do not overload wall outlets and extension cords as this can result in the risk of fire or electric shock.
- Never push objects of any kind into this product through cabinet slots as they may touch dangerous voltage points or short out parts that could result in a risk of fire or electric shock.
- Never spill liquid of any kind on the product.
- To reduce the risk of electric shock, do not disassemble this product. Opening or removing covers may expose you to dangerous voltages or other risks. Incorrect reassembly can cause electric shock during subsequent use.
- Unplug this product from the wall outlet and battery source and refer servicing to qualified service personnel under the following conditions:
  - a. When the power supply cord or plug is damaged or frayed.
  - b. If liquid has been spilled into the product.
  - c. If the product does not operate normally by following the operating instructions.
  - d. If the product has been dropped or damaged.
  - e. If the product exhibits a distinct change in performance.
- Avoid using a telephone during an electrical storm. There may be a remote risk of electric shock from lightning.
- Do not use this product to report a gas leak in the vicinity of the leak.
- Do not use this product near intensive care medical equipment or by persons with pacemakers.
- Due to the radio signals between base station and POD, wearers of hearing aids may experience interference in the form of a humming noise.
- This product can interfere with electrical equipment such as answering machines, TV sets, radios, computers and microwave ovens if placed too close.

**To reduce the risk of fire or injury to persons, read and follow these instructions:**

### Telephone wiring and jack information

- Use caution when installing or modifying telephone lines.
- Never install telephone wiring during an electrical storm.
- Never install telephone jacks in wet locations unless the jack is specifically designed for wet locations.
- Never touch uninsulated telephone wires or terminals unless the telephone line is disconnected at the network interface.

### Batteries

- Disconnect the product from wall outlet when replacing the battery pack.
- Use only the battery pack type listed in this manual. Do not use lithium batteries.
- Do not dispose of the battery pack in a fire, as they can explode. Check with local codes for battery disposal regulations.
- Do not open or mutilate the battery pack. Released electrolyte is corrosive and can cause damage to the eyes or skin. It can be toxic if swallowed.
- Avoid contact with rings, bracelets, keys or other metal objects when handling the battery pack. These objects could short out the batteries or cause the conductor to overheat, resulting in burns.
- Do not attempt to recharge the battery pack by heating it. Sudden release of battery electrolyte can cause burns or irritation to the eyes or skin.

- Observe the proper polarity, or direction, of any battery. Reverse insertion of the battery pack can result in leakage or explosion.
- Remove the battery pack if you do not plan to use the product for several months at a time. The batteries could leak over that time.
- Discard any “dead” battery pack as soon as possible because they are likely to leak into the product.
- Do not store this product or the battery pack in a high temperature area. Battery packs

**WARNING: TO PREVENT FIRE OR ELECTRICAL SHOCK HAZARD, DO NOT EXPOSE THIS PRODUCT TO RAIN OR MOISTURE.**

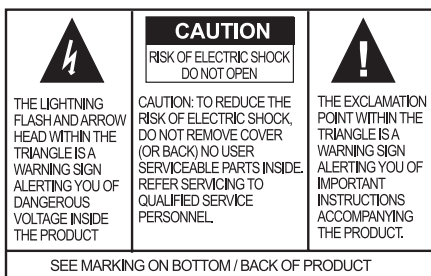

stored in a freezer or refrigerator should be protected from condensation during storage and defrosting. Battery packs should be stabilized at room temperature before using.

- Your battery pack is rechargeable and can be recycled once it outlives its usefulness. Depending upon your local and state law, it might be illegal to dispose of this battery into a municipal waste system. Check with your local solid waste company for more information on your recycling options for the battery pack.

## Save these instructions

### Getting Started

#### Connecting your conferencing phone

1. Slide the cover off the battery compartment on the bottom of the pod.

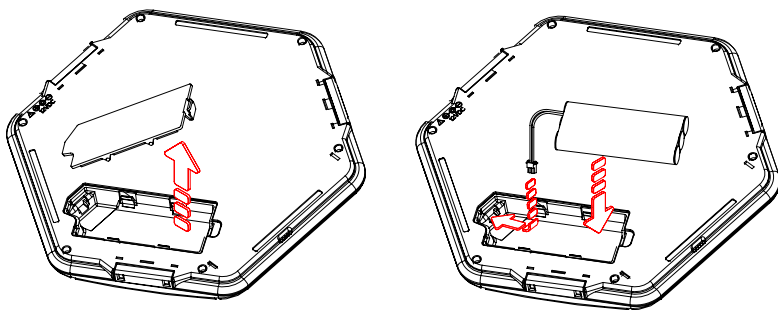



Figure 2. Connecting the battery pack

2. Connect the battery pack plug into the port in the compartment, insert the battery pack, and slide the cover back into place.

 **CAUTION:** Use only the battery pack that came with this unit. Replace only with a same or equivalent type recommended by manufacturer. There is risk of explosion if battery is replaced by an incorrect type.

3. Connect the power adapter to the conferencing pod and plug it into an electrical outlet. This will charge the battery pack.

 Battery packs must be charged at least 15 hours prior to first use.

 **CAUTION:** Use only the power adapter that came with this unit. Using other adapters may damage the unit.

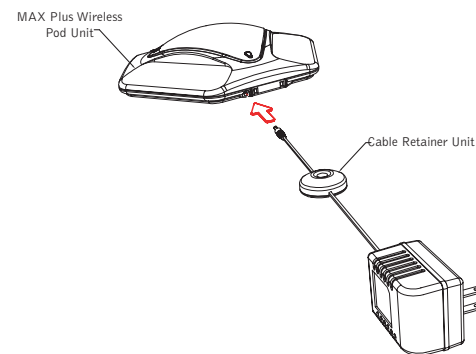

Figure 3. Connecting power supply

4. Connect one end of the telephone cable into the phone jack on the back of the base unit and the other end into a wall jack.

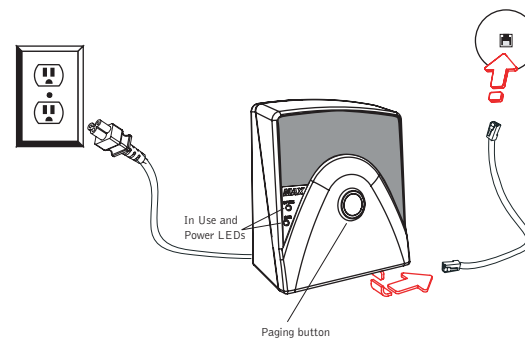

Figure 4. Connecting the base unit

5. Connect a recording device to the 2.5mm mono audio jack (if desired).
6. Connect the power cord to the base unit and plug it into an electrical outlet.

## Connecting to a digital phone line

**WARNING!** Do not connect the conferencing phone directly to a digital (PBX) line, PERMANENT DAMAGE MAY RESULT. If you have digital (PBX) telephone service, you will need a digital-to-analog telephone line converter. For more information, contact ClearOne technical support.

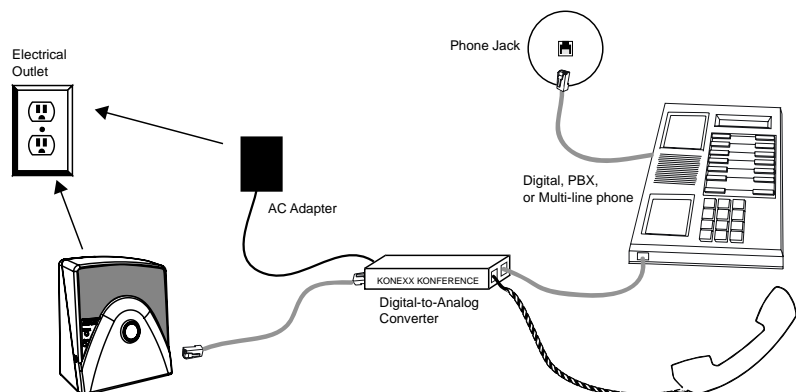

Figure 5. Connecting the base unit to digital-to-analog converter

1. Connect one end of the telephone cable into the phone jack on the back of the base unit and the other end into the digital-to-analog converter.
2. Connect the converter's power adapter into an electrical outlet.
3. Connect a second telephone cable from the converter to a digital or PBX phone. Consult the converter user manual for more information.
4. Plug the base unit into an electrical outlet.

## Using your MAX Wireless conferencing phone

### To make a call

1. Press the **ON/OFF** key. You will hear a dial tone.
2. Dial the number as you would on a standard phone. The number is displayed on the LCD screen.

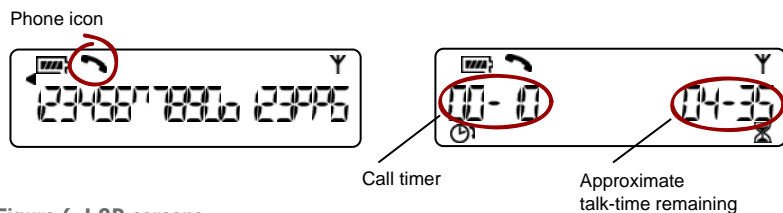



Figure 6. LCD screens

 You can also redial the number while in Standby (inactive) mode and press the **ON/OFF** key to connect the call. Press and hold the pound key (#) to enter a pause in the dialing string.

Elapsed time is shown in minutes and seconds until one hour passes. Then elapsed time is shown in hours and minutes.

### To answer a call

- Press any key (except the star "\*" key, **MUTE**, **VOLUME UP** or **VOLUME DOWN**) on the keypad to answer the call. When there is an incoming call, the phone rings and the LEDs on the phone and the phone icon on the LCD screen flash.

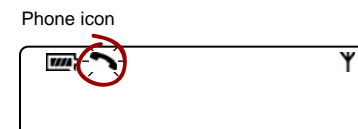

Figure 7. Incoming call

### To end a call

- Press the **ON/OFF** key. This will disconnect the call and return the phone to Standby mode.

### To redial a number

1. Press the **ON/OFF** key. You will hear a dial tone.
2. Press **REDIAL** to dial the last number called.

 You can also press **REDIAL** while in Standby mode to display the last number called. To connect the call, press the **ON/OFF** key.

### To adjust ringer volume

- While the phone is ringing, press **VOLUME UP** or **VOLUME DOWN**.
- While the phone is inactive, press **VOLUME UP** or **VOLUME DOWN**. The ringer melody will play once at the new level.

### To mute the call

- Press **MUTE** to mute the call.
- Press again to unmute.

### To make a call using the Phonebook

1. Press the **ON/OFF** key. You will hear a dial tone.
2. Press **PHONEBOOK**.
3. Press the number key (0-9) that corresponds with the location of the stored phone number you want to dial. This feature must be programmed before use. See page 8.

### To store a number in the phonebook

1. Enter the phone number you want to store while conferencing pod is in Standby mode.
2. Press and hold the **PHONEBOOK/EDIT** key until the Phonebook and Program icons appear on the LCD screen.

Phonebook and Program icons

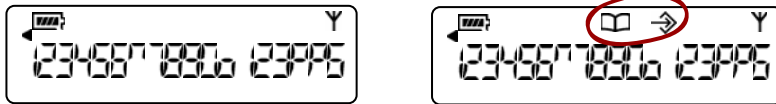



Figure 8. Adding Phonebook entries

3. Assign a Phonebook location (0–9) by pressing the corresponding number key.
4. Press **PHONEBOOK** again to save the entry. You will hear a confirmation tone.
5. To exit Phonebook Edit mode before saving the entry, press **CLEAR**.

 Press & hold the "1" key to enter a hyphen or the "\*" key to enter a space in the number. Use **CLEAR** to delete the old number before entering a new number.

### To access your speed dial number

- Press the **SPEED DIAL** key. This feature must be programmed before use. See page 10.

### To access your service center

- While in Standby mode, press and hold the **0** key for 2 seconds. This feature must be programmed before use. See page 10.

## User Options

### Call features

In addition to the basic phone operations described in the previous section, you can perform any of the following functions during a call: change to pulse dialing, send a flash signal, display phone number, adjust speaker volume, or turn on/off the ringer.

#### To use pulse dialing

The MAX Wireless uses tone dialing by default. You can temporarily change to pulse dialing during a call.

- Press the star (\*) key. A special character will appear. All numbers entered after this character will use pulse dialing. When the call is finished, the dialing mode will revert to tone.

 When more than 18 characters are entered, a scroll button will appear on the LCD display and the numbers will scroll from right to left.

### To send a Flash signal

If your telephone service includes call transfer, call waiting, or conference calling, you can use the Flash key. Refer to your local telephone service for details.

### To display your local number during a call

- Press **CLEAR**. The phone number will appear. After several seconds, the call timer will return.

### To adjust loudspeaker volume

- Press the **VOLUME UP** key while on a call to increase volume.
- Press the **VOLUME DOWN** key while on a call to decrease volume.

### To turn the ringer on/off

- Press and hold the star (\*) key. The Ringer Off icon will illuminate when ringer is turned off. The icon will not appear when the ringer is on.

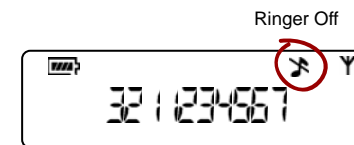

Figure 9. Ringer Off icon. When the ringer is off, LEDs & the phone icon will flash to indicate incoming call.

### To mute during ringing

- Press the star (\*) or the **MUTE** key to mute the ringer for the duration of the ringing.

## Programming features

To allow for individual preferences and enhance ease of use, seven features can be programmed: Ringer melody, dialing mode, flash duration, local phone number, speed dial number, service center number, and AGC/ALC. You may also restore factory defaults.

### To change ringer melody

1. Press and hold the **REDIAL/PROG** key until the Program icon appears on the LCD screen.

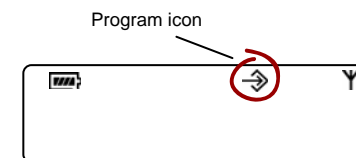

Figure 10. Programming options

2. Press **1** to enter the Ringer Melody menu. There are five available melodies.
3. Press **REDIAL/PROG**. The current melody selection will flash.
4. Press keys **1–5** to play the corresponding melody. The selected melody will play once.
5. Press **REDIAL/PROG** to save the selection. Press **CLEAR** to exit programming.

### To change dialing mode

1. Press and hold the **REDIAL/PROG** key until the Program icon appears on the LCD screen.
2. Press **2** to enter the Dialing Mode menu. There are two dialing modes: tone and pulse. The current dialing mode will be displayed (T for tone, P for pulse).
3. Press **REDIAL/PROG**. The current mode will flash.
4. Press **1** to select tone or **2** to select pulse.
5. Press **REDIAL/PROG** to save the selection. Press **CLEAR** to exit.

### To change flash duration

1. Press and hold the **REDIAL/PROG** key until the Program icon appears on the LCD screen.
2. Press **3** to enter the Flash Duration menu. The current duration will be displayed in milliseconds. There are five duration settings: 600, 300, 150, 100 and 80.
3. Press **REDIAL/PROG**. The current duration will flash.
4. Press keys **1–5** to select a new duration setting.
5. Press **REDIAL/PROG** to save the selection. Press **CLEAR** to exit.

### To program local phone number

1. Press and hold **REDIAL/PROG** until the Program icon appears on the LCD screen.
2. Press **4** to enter the user phone number menu.
3. Press **REDIAL/PROG**.
3. Enter the local phone number.
4. Press **REDIAL/PROG** to save the number. Press **CLEAR** to exit.

 Press & hold the “1” key to enter a hyphen or the “\*” key to enter a space in the number. Use **CLEAR** to delete the old number before entering a new number.

### To program speed dial number

1. Press and hold **REDIAL/PROG** until the Program icon appears on the LCD screen.
2. Press **5** to enter the Speed Dial menu.
3. Press **REDIAL/PROG**.

4. Enter the phone number.
5. Press **REDIAL/PROG** to save the number. Press **CLEAR** to exit.

 Press & hold the “1” key to enter a hyphen or the “\*” key to enter a space in the number. Use **CLEAR** to delete the old number before entering a new number.

### To program service center number

1. Press and hold the **REDIAL/PROG** key until the Program icon appears on the LCD screen.
2. Press **6** to enter the service center menu.
3. Press **REDIAL/PROG**.
4. Enter the number you want the 0 key to dial.
5. Press **REDIAL/PROG** to save the number. Press **CLEAR** to exit.

 Press & hold the “1” key to enter a hyphen or the “\*” key to enter a space in the number. Use **CLEAR** to delete the old number before entering a new number.

### To restore factory defaults

1. Press and hold the **REDIAL/PROG** key until the Program icon appears on the LCD screen.
2. Press and hold the **9** key. The number 8 will be displayed across the LCD screen.
3. Press **REDIAL/PROG** to confirm selection. Press **CLEAR** to exit.

### To program the Automatic Gain Control (AGC) and Automatic Level Control (ALC) settings

1. Press and hold the **REDIAL/PROG** key until the Program icon appears on the LCD screen.
2. Press and hold the **8** key. The current AGC setting number will be displayed on the LCD screen.
3. Press **REDIAL/PROG**. The current setting number will flash.
4. Enter a new setting number using the table.
5. Press **REDIAL/PROG** to confirm selection. Press **CLEAR** to exit.

Setting	Speaker AGC	Microphone ALC
1	On	On
2	On	Off
3	Off	On
4	Off	Off



## Tones and alerts

Tone/Alert	Description
Not powered	If the base unit is not powered, you will hear a beeping sound when you press the Phone key.
Confirmation	A tone will play upon successful programming entry.
Reject	A tone will play if you attempt to do any of the following: <ul style="list-style-type: none"> <li>enter an invalid programming entry</li> <li>use a speed dial key that has not been programmed (speed dial or service center)</li> <li>enter a 45th digit when predialing</li> <li>enter a 17th digit for user phone number</li> <li>enter a 31st digit for speed dial key (One-Touch Conferencing or service center)</li> </ul>
Low Battery	An alert will sound every 60 seconds when batteries require charging and conferencing pod is in Phone mode.
Out of Range	An alert will sound every 30 seconds when conferencing pod is too far from base unit and in Phone mode.
Paging	When the Page button on the base unit is pressed, the conferencing pod will beep loudly for 30 seconds or until any key on the keypad is pressed.

## MaxAttach Wireless

### Using the MAXAttach Wireless Conferencing System

The MAXAttach Wireless is a dual-pod conferencing system. The MAXAttach Wireless conferencing pods function only with their associated base unit. The base unit and conferencing pods are programmed at the factory and have matching serial numbers: the serial number for the base is found on a label on the back of the base and the serial number for the pods is found on a label on the bottom of each pod.

There are a few minor differences between single-pod and dual-pod operation, as detailed in the following paragraphs.

#### Answering a call

- Both pods ring during an incoming call. Each pod's ringer melody and volume depends on that pod's settings. Pressing **ON/OFF** on either pod activates both pods.

## During a call

- Changing the speaker volume, and muting or unmuting the microphone, causes both pods to change simultaneously.
- If one pod loses its link to the base due to low battery power or being moved out of range, the call will continue on the other pod.

## Ending a call

- Pressing **ON/OFF** on either pod ends the call and places both pods into stand-by mode, ready for another call.

## Maintenance

### Caring for your MAX Wireless

- Follow all warnings and instructions marked on your MAX Wireless.
- Unplug base unit and conferencing pod from the wall outlet before cleaning.
- Do not use liquid or aerosol cleaners. Use a damp cloth moistened with water to clean the outside of your conferencing pod or base unit and power supply.

### Electrical considerations

- Use only the power adapter that comes with your conferencing phone.
- Use only the battery pack that ships with your phone.

### Troubleshooting

If you are having trouble with your MAX Wireless, it might be improperly set up or other equipment might be malfunctioning. To begin, check for the following or consult the chart on the next page:

- The Max Wireless base unit is plugged into the proper volt electrical outlet and its power light is on.
- The battery pack in the pod section is fully charged and plugged in correctly.
- The telephone cord from the base unit is securely connected to the telephone wall jack.
- The equipment the other party is using is comparable in quality to your Max Wireless conferencing phone and is working properly. While the Max Wireless works with lower quality products, the quality of the conference will be impacted if the party you are conferencing with has poor quality equipment.



If you hear	It could be that	Try this
Beeping sound before dialing	Pod section is out of range  Base unit is not powered.	Move pod section closer to the base unit.  Make sure base unit is plugged into a power outlet and the Power LED is lit.
No dial tone	Base unit is not connected to telephone jack.  You are not using an analog phone line.	Connect the base unit to the telephone jack using the supplied telephone cable.  Check that you are using an analog phone line. Consult your IT department for help.
Static or noise	You have a bad telephone connection.  You have a bad telephone line.  The other party's room is too noisy.	Place the call again to see if another line provides a better connection.  Plug a working phone into the phone jack. If the line is still noisy, call your telephone company.  Ask the other party to turn off noisy equipment.
Calls can come in, but you can't dial out.	The dialing mode (tone or pulse) is set incorrectly for your service.	See page 10 for instructions on changing the dialing mode.
Poor audio	Building construction is limiting phone range.  The equipment on the far end is of lesser quality.	Move base unit closer to the phone.  The equipment should be upgraded. Participants can try sitting closer to equipment and eliminate background noises.

## Appendix

### Specifications

#### DIMENSIONS (W x D x H)

Phone section: 10.5" x 10.5" x 3"  
(26.7 cm x 26.7 cm x 7.6 cm)  
Base unit: 4.25" x 5.5" x 2.5"  
(10.8 cm x 14 cm x 6.4 cm)

#### WEIGHT

Phone section: 2.7 lb (1.2 kg)  
Base unit: .6 lb (0.27 kg)  
Shipping: 10 lb (4.5 kg)

#### ENVIRONMENTAL

Operating Temperature: 0–50° C  
(32–122° F)  
Storage temperature: 5–70° C  
(41–158° F)  
Operating Humidity: 15 to 80%  
Storage humidity: 10 to 90%

#### POWER

Pod section:  
Custom battery pack with nickel metal hydride batteries, 7.2 V  
2200 mAh  
12 hours continuous talk time  
(typical)

Base unit:  
Auto-adjusting power module;  
100–240VAC; 50/60 Hz

#### TELEPHONE CONNECTION

Analog PBX or PSTN line  
RJ-11C/CA11A, –12dBm nominal

#### KEYPAD

Alphanumeric standard keypad

#### LOUDSPEAKER VOLUME

90 dBspl A weighted @ 1 ft  
Bandwidth: 200Hz - 3.3kHz

#### RADIO FREQUENCY

2.4 GHz WDCT  
1.8 GHz DECT  
(4) 32kbps full duplex

#### RECORD OUTPUT

Connector: 2.5 mm mono audio jack  
Impedance: <1000 ohms  
Bandwidth: 200Hz–3.3kHz  
Dynamic Range: 60dB  
THD <.01%

#### ECHO CANCELLATION

Tail Time: 60 ms x 3

#### NOISE CANCELLATION

Dynamic noise cancellation

#### CERTIFICATIONS

FCC Part 15/ICES-003 Class A  
FCC Part 15 Subpart C/RSS-210  
FCC Part 68/IC CS-03  
CE  
UL, C-UL Certified

#### WARRANTY

2 Years

#### MODELS

MAX Wireless WDCT\*  
MAX Wireless DECT\*

\*Call your sales representative for part numbers.

## Compliance

### FCC Part 15/ICES-003 Compliance

This equipment has been tested and found to comply with the limits for a Class A digital device, pursuant to Part 15 of the FCC rules and Industry Canada ICES-003. These limits are designed to provide reasonable protection against harmful interference when the equipment is operated in a commercial environment. This equipment generates, uses, and can radiate radio frequency energy and, if not installed and used in accordance with the instruction manual, may cause harmful interference to radio communications. Operation of this equipment in a residential area is likely to cause harmful interference, in which case the user will be required to correct the interference at his/her own expense.

Operation is subject to the following two conditions: (1) This device may not cause interference, and (2) This device must accept any interference including interference that may cause undesired operation of the device.

Changes or modifications not expressly approved by ClearOne Communications could void the user's authority to operate the equipment.

### FCC Part 15 Subpart C/RSS-210

#### Noise

Electrical pulse noise is present in most businesses at one time or another. This is most intense during electrical storms. Certain kinds of electrical equipment, such as light dimmers, fluorescent bulbs, motors, fans, etc., also generate pulse noise. Because radio frequencies are susceptible to this, you may on occasion hear pulse noise through the speaker; this is usually only a minor annoyance and should not be interpreted as a defect of the unit.

#### RF Radiation Exposure

This equipment complies with FCC RF Radiation Exposure limits set forth for the uncontrolled environment. This equipment should be installed and operated with a minimum distance of 20 centimeters between radiator and your body.

### FCC Part 68/IC CS-03 Compliance

US:FBIWI01B910158001 Ringer Equivalence Number (REN): 0.1B(ac)

This equipment complies with Part 68 of FCC Rules and Technical Requirements for Telephone Terminal Equipment published by ACTA. The marking on the base unit of this equipment contains, among other information, the US number and ringer Equivalence Number (REN) for this equipment. If requested, this information must be provided to your telephone company.

The REN is used to determine the quantity of devices, which may be connected to the telephone line. Excessive RENs on the telephone line may result in the devices not ringing in response to an incoming call. In most, but not all areas, the sum of the RENs should not exceed five (5.0). To be certain of the number of devices that may be connected to the line, as determined by the total RENs, contact the telephone company to obtain the maximum RENs for the calling area.

If this equipment causes harm to the telephone network, the telephone company will notify you in advance that temporary discontinuance of service may be required. If advance notice is not practical, the telephone company will notify the customer as soon as possible. Also, you will be advised of your right to file a complaint with the FCC if you believe it is necessary.

The telephone company may make changes in its facilities, equipment, operations, or procedures that could affect the operation of the equipment. If this happens, the telephone company will provide advance notice for you to make the necessary modifications in order to maintain uninterrupted service.

## Notice

A plug and jack used to connect this equipment to the premises wiring and telephone network must comply with the applicable FCC Part 68 Rules and Requirements adopted by the ACTA. A compliant telephone cord and modular plug is provided with this product. It is designed to be connected to a compatible modular jack that is also compliant. See installation instructions for details.

If you experience problems with this equipment, contact ClearOne Communications, 5225 Wiley Post Way, Salt Lake City, Utah 84116, or by phone at (801) 975-7200 for repair and warranty information. If the trouble is causing harm to the telephone network, the telephone company may request you remove the equipment from the network until the problem is resolved.

No user serviceable parts are contained in this product. If damage or malfunction occurs, contact ClearOne Communications for instructions on its repair or return.

This equipment cannot be used on telephone company provided coin service. Connection to Party Line Service is subject to state tariffs.

## IC Compliance

IC: 1970A-910158

Ringer Equivalence Number (REN): 0.1B(ac)

## Notice

The term "IC" before the certification/registration number signifies that Industry of Canada technical specifications were met.

This certification means that the equipment meets certain telecommunications network protective operational and safety requirements. The Department does not guarantee the equipment will operate to the user's satisfaction.

The REN is used to determine the quantity of devices, which may be connected to the telephone line. Excessive RENs on the telephone line may result in the devices not ringing in response to an incoming call. In most, but not all areas, the sum of the RENs should not exceed five (5.0). To be certain of the number of devices that may be connected to the line, as determined by the total RENs, contact the telephone company to obtain the maximum RENs for the calling area.

Before installing this equipment, users should ensure that it is permissible to be connected to the facilities of the local telecommunications company. The equipment must also be installed using an acceptable method of connection. In some cases, the companies inside wiring associated with a single line individual service may be extended by means of a certified connector assembly (telephone extension cord). The customer should be aware that compliance with the above conditions may not prevent degradation of service in some situations.

Repairs to certified equipment should be made by an authorized Canadian maintenance facility designated by ClearOne Communications. Any repairs or alterations made by the user to this equipment, or equipment malfunctions, may give the telecommunications company cause to request the user to disconnect the equipment.

Users should ensure for their own protection that the electrical ground connections of the power utility, telephone lines and internal metallic water pipe system, if present, are connected together. This precaution may be particularly important in rural areas.

## European Compliance

This equipment has been approved in accordance with Council Directive 1999/5/EC "Radio Equipment and Telecommunications Equipment" (see insert enclosed with phone).

## Warranty

ClearOne Communications, Inc. (Manufacturer) warrants that this product is free of defects in both materials and workmanship. For warranty information and coverage, refer to the ClearOne website at [www.clearone.com](http://www.clearone.com).

ClearOne Communications, Inc.  
5225 Wiley Post Way  
Salt Lake City, Utah 84116